



2298 NORTH SECOND ST.
NORTH ST. PAUL, MN 55109
PHONE 651-770-2356
FAX 651-770-0439
www.custommillworkinc.com

Welcome to Custom Millwork Inc.

Custom Millwork Inc. has been serving the professional contractor for over 35 years. Our 40+ experienced employees are dedicated to providing superior customer service and quality products. Custom Millwork's success depends upon our customer's total satisfaction.

Custom Millwork Inc. sales representatives and sales support personnel specialize in serving the regional custom home builder, national single/multi home builder, and multi family commercial contractor with three separate sales divisions. Your Custom Millwork sales representative is a specialist to meet your building needs.

Visit our 3000 square foot product showroom and see for yourself why.

"The professional builder and Custom Millwork Inc. are a quality combination you can build on."

PROFILE	DESCRIPTION	OAK	MAPLE	PRIMED	CHERRY	POPLAR	K. ALDER
CASING							
CM367	7/16" × 2-1/4" Princeton Casing	✓	✓	✓	✓	✓	
CM157	7/16" × 2-1/4" E.E. Casing	✓	✓	✓		✓	
C131	11/16" × 3-1/4" Colonial Casing	✓	✓	✓	✓		
C338	3/4" × 3-3/8" Backband Casing	✓	✓	✓			✓
BASE CAP							
C240A	5/8" × 3/4" Base Cap	✓	✓				
BASE SHOE							
C127	7/16" × 3/4" Base Shoe	✓	✓	✓	✓	✓	✓
DOOR STOP							
C876	3/8" × 1-1/4" Round Edge Stop	✓	✓	✓	✓	✓	✓
C885	1/2" × 1-1/2" Round Edge Stop	✓	✓	✓	✓		
C112	11/16" × 1-1/2" Round Edge Stop	✓	✓	✓		✓	
C306	3/8" × 1-1/4" Princeton Stop	✓	✓	✓	✓	✓	
BASE							
CM635	3/8" × 2-3/4" Princeton Base	✓	✓	✓	✓	✓	
CM238	3/8" × 3-1/4" E.E. Base	✓	✓	✓		✓	
C275V	7/16" × 4-1/4" Princeton Base	✓ (*V)	✓ (*V)	✓ (*FJ)	✓ (*V)		✓ (*S)
C434V	1/2" × 4-3/4" E.E. Base	✓ (*V)	✓ (*V)	✓ (*FJ)			
C280	5/8" × 5-1/4" Colonial Base	✓ (*V)	✓ (*S)	✓ (*FJ)	✓ (*S)		

✓ = STOCK ITEM

*V = VENEER

*S = SOLID

*FJ = FINGER JOINT POPLAR



CUSTOM MILLWORK, INC.

2298 North 2nd St. • North St. Paul, MN 55109 • 651-770-2356 • Fax 651-770-0439 • www.custommillworkinc.com

CASING

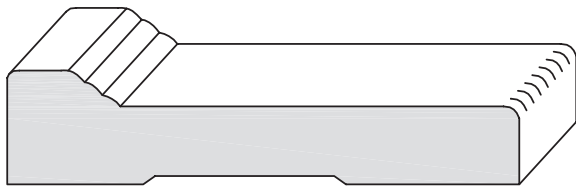
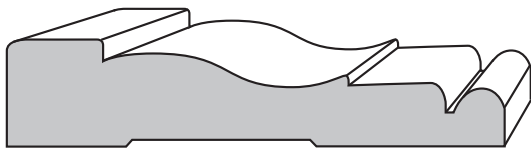
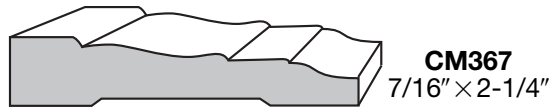

BASE

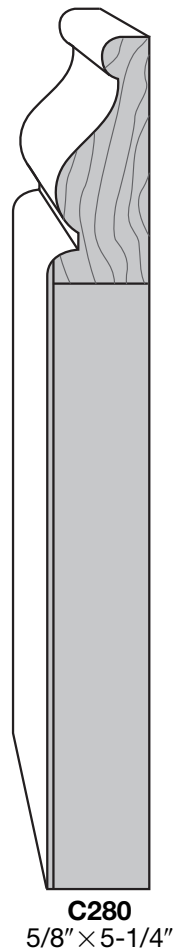
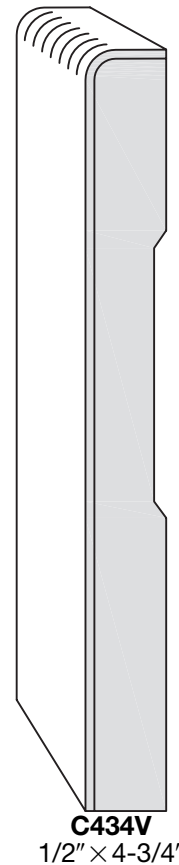
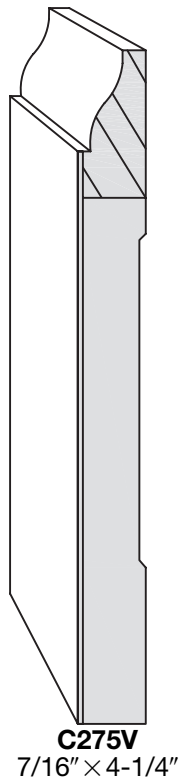
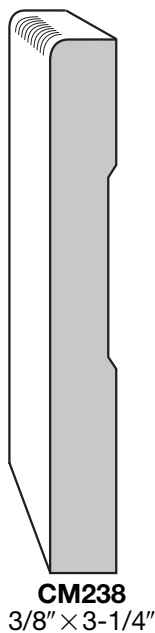
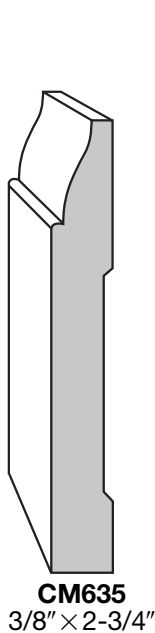

BASE CAP



BASE SHOE



DOOR STOP

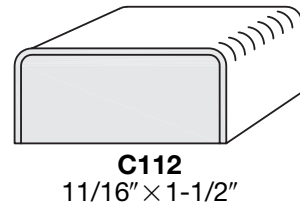
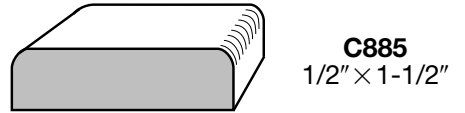

CUSTOM MILLWORK, INC.

2298 North 2nd St. • North St. Paul, MN 55109 • 651-770-2356 • Fax 651-770-0439 • www.custommillworkinc.com

PROFILE	DESCRIPTION	OAK	MAPLE	PINE	PRIMED	CHERRY	POPLAR	K. ALDER
PANEL MOULDING								
C710	1-1/16" × 2" Panel Moulding		✓					
C729	7/16" × 3/4" Panel Moulding					✓		
C720	11/16" × 2-5/8" Panel Moulding	✓	✓			✓		
C723	3/4" × 1-5/16" Panel Moulding					✓		
C732	11/16" × 1" Panel Moulding					✓		
C8081	1-1/16" × 1-13/16" Nosing/Cove	✓	✓			✓	✓	✓
SCLOVER	7/8" × 1/2" Small Clover	✓	✓			✓	✓	✓
CLOVER	1-1/4" × 3/4" Clover	✓	✓			✓	✓	✓
MULL CENTER								
C500A	1/4" × 1-1/4" Mull Center	✓	✓			✓	✓	
C500C	1/4" × 1-3/4" Mull Center	✓	✓	✓				
C500E	1/4" × 2-1/4" Mull Center	✓						
C500F	1/4" × 2-1/2" Mull Center	✓	✓			✓	✓	
C500J	1/4" × 4" Mull Center	✓	✓	✓		✓		
C500N	1/4" × 6" Mull Center	✓	✓					
CROWN & COVE MOULDING								
C614	11/16" × 4-1/4" Crown Mldg. Projection 2-5/8" Drop 3-5/16"	✓	✓		✓	✓		
C610	11/16" × 3-7/16" Crown Mldg. Projection 2-1/8" Drop 2-9/16"	✓	✓			✓		
C613	1-1/16" × 5-3/8" Cove Mldg. Projection 3-9/16" Drop 3-13/16"		✓					
5834SC	5/8" × 3/4" Super Cove	✓	✓			✓	✓	
NCOVE	7/8" Newel Cove	✓	✓			✓	✓	✓
LNCOVE	7/8" × 1-3/8" Large Newel Cove	✓	✓			✓	✓	✓

✓ = STOCK ITEM



CUSTOM MILLWORK, INC.

2298 North 2nd St. • North St. Paul, MN 55109 • 651-770-2356 • Fax 651-770-0439 • www.custommillworkinc.com

PANEL MOULDING CROWN & COVE

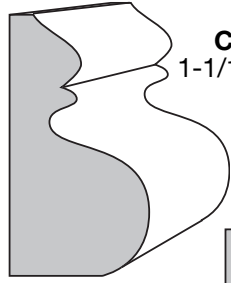

C710
1-1/16" x 2"

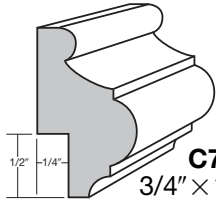

C723
3/4" x 1-5/16"

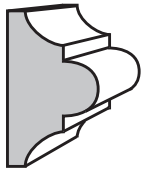

C729
7/16" x 3/4"

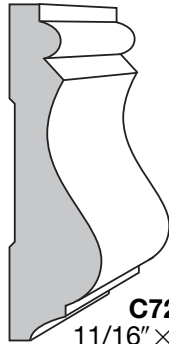

C720
1 1/16" x 2-5/8"

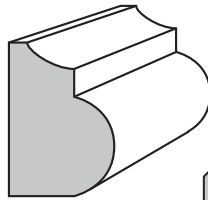

C732
1 1/16" x 1"

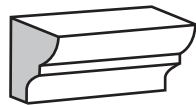

5834SC
5/8" x 3/4"

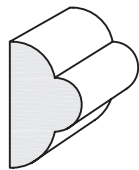

SCLOVER
7/8" x 1/2"

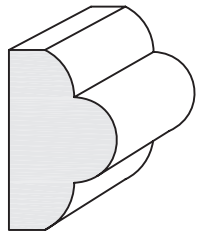

CLOVER
1-1/4" x 3/4"

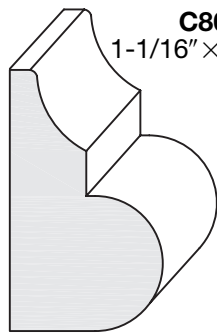

C8081
1-1/16" x 1-13/16"

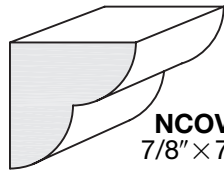

NCOVE
7/8" x 7/8"

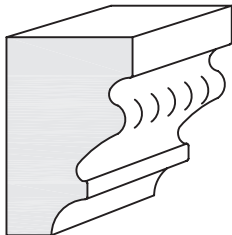

LNCOVE
7/8" x 1-3/8"

MULL CENTER



C500A
1/4" x 1-1/4"



C500C
1/4" x 1-3/4"

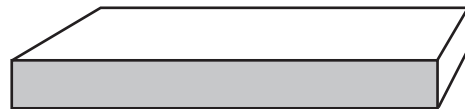

C500E
1/4" x 2-1/4"

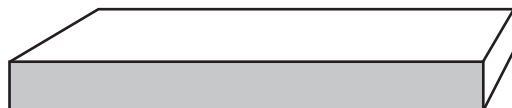

C500F
1/4" x 2-1/2"



C500J
1/4" x 4"

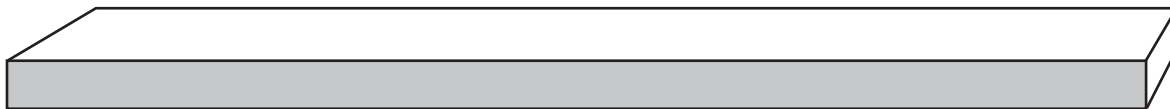

C500N
1/4" x 6"



CUSTOM MILLWORK, INC.

2298 North 2nd St. • North St. Paul, MN 55109 • 651-770-2356 • Fax 651-770-0439 • www.custommillworkinc.com

PROFILE	DESCRIPTION	OAK	MAPLE	PINE	PRIMED	CHERRY	POPLAR	K. ALDER
MULL CENTER								
C433PR	11/16" × 3-1/4" Hookstrip				✓			
C472PR	11/16" × 2-1/2" Hookstrip				✓			
MISCELLANEOUS MOULDINGS								
WM142	1/4" × 3/4" Screen Moulding			✓				
C1001	1/2" × 3/4" Parting Stop			✓				
C320	Astragal for 1-3/8" Door	✓	✓			✓	✓	✓
C323	Astragal for 1-3/4" Door	✓	✓			✓		
WM233	1-5/16" Closet Pole						✓	
WBMLF	1-1/4" × 2" Brick Moulding				✓			
WNDEXT	3/4" × 2-1/4" Window Extension			✓				
5916W_JM	11/16" × 5-9/16" Window Extension	✓ (V)	✓ (V)		✓ (V) white			
MISCELLANEOUS MOULDINGS								
BOC10	1-1/4" × 3-3/4" O.S. Corner	✓						
OC1018	1-1/4" × 18" Skirtboard O.S.	✓	✓			✓		
BIC10	3/4" × 3-3/4" I.S. Corner	✓						
BOC178RAD	1-1/4" Base O.S. Corner Rad.	✓	✓					
JJTJB	7/8" × 2-1/2" Bullseye Block	✓	✓					
CMTB	11/16" × 2-1/2" Bullseye Block	✓	✓			✓	✓	
BTB21	11/16" × 3-3/4" Bullseye Block	✓	✓			✓	✓	
PB11	11/16" × 2-1/2" × 6-1/2" Plinth Block	✓	✓					
CMIC30	Crown Moulding I.S. Corner	✓	✓					
MBB	3-3/4" Base Mid Room Block	✓	✓					

✓ = STOCK ITEM

V = VENEERED



CUSTOM MILLWORK, INC.

2298 North 2nd St. • North St. Paul, MN 55109 • 651-770-2356 • Fax 651-770-0439 • www.custommillworkinc.com

HOOKSTRIP

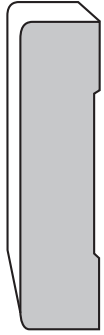

C433PR
11/16" × 3-1/4"

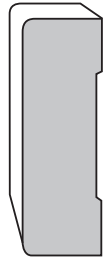

C472PR
11/16" × 2-1/2"

MISCELLANEOUS MOULDINGS

SCREEN MOULDING



WM142
1/4" × 3/4"

PARTING STOP

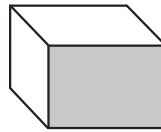

C1001
1/2" × 3/4"

CLOSET POLE

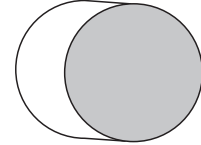

WM233
1-5/16"

ASTRAGAL

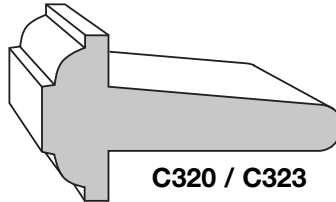

C320 / C323

BRICK MOULDING

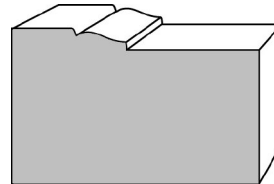

WBMLF
1-1/4" × 2"

WINDOW EXTENSIONS

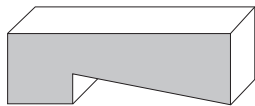

WNDXT
3/4" × 2-1/4"



5916W_JM
11/16" × 5-9/16"

TARGET / PLINTH BLOCKS



JJTB
7/8" × 2-1/2"

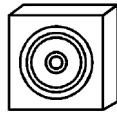

CMTB
11/16" × 2-1/2"

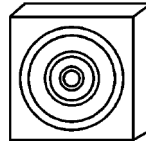

BTB21
11/16" × 3-3/4"

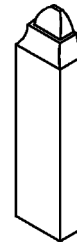

MBB
3-3/4"

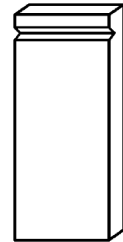

PB11
11/16" × 2-1/2" × 6-1/2"

CORNER BLOCKS

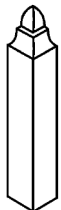

BIC10
3/4" × 3-3/4"

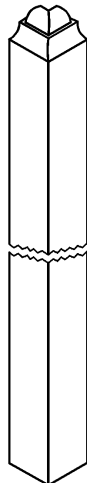

OC1018
1-1/4" × 18"



BOC10
1-1/4" × 3-3/4"



BOC178RAD
1-1/4"



CMIC30
A — 3-9/16"
B — 2-13/16"
for 4-1/4" Crown



CUSTOM MILLWORK, INC.

2298 North 2nd St. • North St. Paul, MN 55109 • 651-770-2356 • Fax 651-770-0439 • www.custommillworkinc.com

PROFILE	DESCRIPTION	OAK	MAPLE	PARTICLE BOARD	CHERRY	POPLAR	K. ALDER
TREADS AND RISERS							
PBT	10-1/2" & 11-1/2" Treads			✓			
PT60	11-1/4" × 60" Ven. End Tread w/Return	✓	✓		✓		
PBR	7-1/2" Risers			✓			
OT	1-1/16" × 11-1/2" Solid Treads	✓					
OR	3/4" × 7-1/2" Solid Risers	✓					
C8011	Starting End Cap L.H. & R.H.	✓ (V)	✓ (V)		✓ (V)		
FTNR	1-1/16" × 6-1/2" × 11-1/2" False End	✓ (V)	✓ (V)		✓ (V)		
FT_	1-1/16" × 7-3/8" × 11-1/2" End w/Return	✓ (V)	✓ (V)		✓ (V)		
FR	1/2" × 6-1/2" × 7-1/2" False Riser	✓ (V)	✓ (V)		✓ (V)		
LANDING TREAD							
LT55	1-1/16" × 5-1/2" Landing Tread	✓	✓		✓	✓	
STAIR NOSING							
NS125	1-1/16" × 1-1/4" Stair Nosing	✓	✓			✓	
SKIRTBOARDS							
SB	7/16" × 9-1/4" E.E. Skirtboard	✓ (V)	✓ (V)		✓ (V)	✓	
SB	7/16" × 9-1/4" Princeton Skirtboard	✓ (V)	✓ (V)		✓ (V)	✓ (V)	✓ (V)
WOOD PLUGS							
C3000	1" Wood Plug	✓	✓		✓		
_B	1/2" Wood Button Plug	✓	✓				
STAIR PART FASTENERS							
MLOCK	Handrail Minilock						
TLNF	Newel Post Threadlock	✓	✓				
NAP	Newel Post Surfalock						
KLNAP	Newel Post Keylock						
C3001	Handrail Bolt						

✓ = STOCK ITEM

V = VENEERED



CUSTOM MILLWORK, INC.

2298 North 2nd St. • North St. Paul, MN 55109 • 651-770-2356 • Fax 651-770-0439 • www.custommillworkinc.com

TREADS AND RISERS

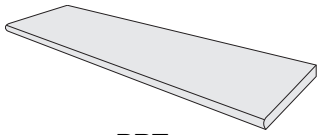

PBT
10-1/2" & 11-1/2"

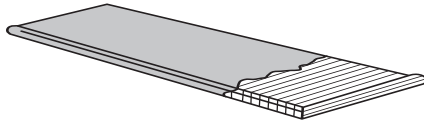

PT60
11-1/4" x 60"



PBR
7-1/2"

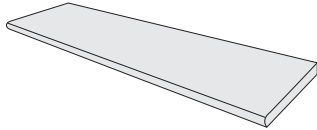

OT
1-1/16" x 11-1/2"

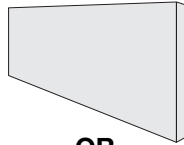

OR
3/4" x 7-1/2"

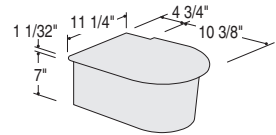

C8011

FALSE TREADS

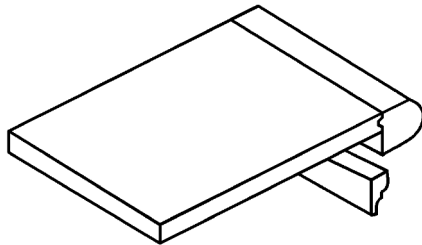

FTNR
1-1/16" x 6-1/2" x 11-1/2"

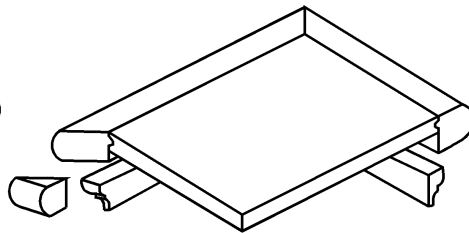

FT L or R
1-1/16" x 7-3/8" x 11-1/2"



FR
1/2" x 6-1/2" x 7-1/2"

LANDING TREAD

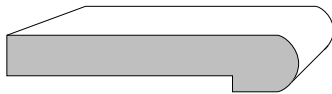

LT55
1-1/16" x 5-1/2"

STAIR NOSING

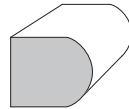

NS125
1-1/16" x 1-1/4"

VENEERED SKIRTBOARD

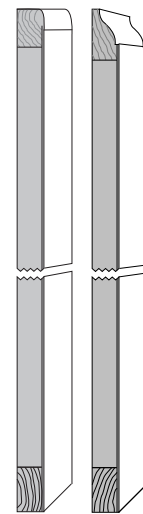

SB
7/16" x 9-1/4"

STAIR PART FASTENERS



B
1/2"



C-3000
1"

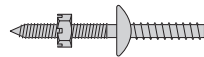

C3001
3-1/2"

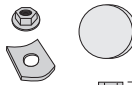

TLNF
4 1/2" / 5 1/2"
3/8" / 1/2"



MLOCK

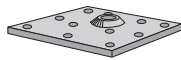

NAP



KLNAP



CUSTOM MILLWORK, INC.

2298 North 2nd St. • North St. Paul, MN 55109 • 651-770-2356 • Fax 651-770-0439 • www.custommillworkinc.com

PROFILE	DESCRIPTION	OAK	MAPLE	PRIMED	POPLAR	CHERRY
HANDRAIL						
C6005	2-17/32" × 2-5/16" with 1-3/4" Plow	✓				
C6010	2-1/4" × 2-3/8"	✓	✓		✓	✓
C6010P	2-1/4" × 2-3/8" with 1-1/4" Plow	✓	✓		✓	✓
C902	1-3/4" × 1-3/8" Wall Rail	✓	✓		✓	
SHOERAIL						
C6006	1" × 3-1/8" with 1-3/4" Plow	✓				
C6045	3/4" × 2-1/2" with 1-1/4" Plow	✓	✓			✓
BALUSTERS						
C5005	1-3/4" Top	✓				
C5015	1-1/4" Pin Top	✓	✓	✓		
C5067	1-1/4" Top	✓				
C5060/C910	1-1/4" S4S	✓	✓	✓	✓	
C5070	1-1/4" Top		✓	✓		
ROSETTE						
C7337	Oval Rosette	✓	✓		✓	✓
FITTINGS						
C7010	Starting Easing	✓				✓
C7011	Level Quarter Turn	✓	✓			✓
C7012	Up Easing	✓				✓
C7019	Opening Cap	✓				✓
C7020	Tandem Cap					✓
C7021	Quarter Turn with Cap					✓
C7022	45 Degree Quarter Turn with Cap					✓
C7040	L.H. Turnout					✓
C7045	R.H. Turnout					✓
C7099	2 Riser No Cap		✓			✓

✓ = STOCK ITEM



CUSTOM MILLWORK, INC.

2298 North 2nd St. • North St. Paul, MN 55109 • 651-770-2356 • Fax 651-770-0439 • www.custommillworkinc.com

RAILS

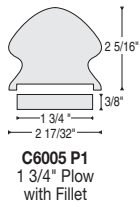

C6005 P1
1 3/4" Plow
with Fillet

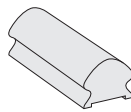

C6005 P1
1 3/4" Plow

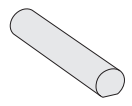

C902

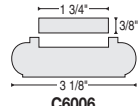

C6006
Shoe Rail
with Fillet

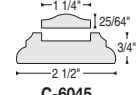

C-6045
Shoe Rail
with Fillet

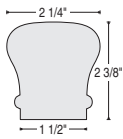

C6010

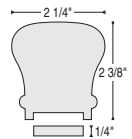

6010 P
with Fillet

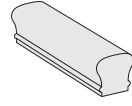

C6010

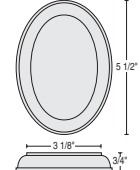

C7337 - Rosette

BALUSTERS

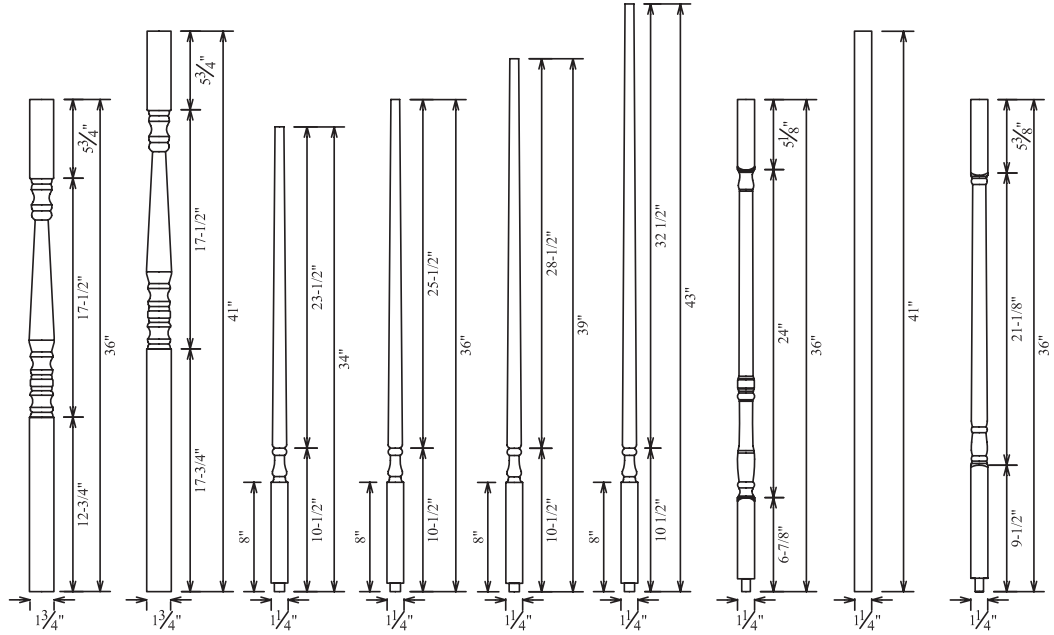

C-5005 1-3/4" SQ. C-5005 1-3/4" SQ. C-5015 1-1/4" SQ. C-5015 1-1/4" SQ. C-5015 1-1/4" SQ. C-5015 1-1/4" SQ. C-5015 1-1/4" SQ. C-5067 1-1/4" SQ. C-5060/C910 1-1/4" S4S C-5070 1-1/4" SQ.

FITTINGS



C7010
Starting Easing
With Cap



C7011
Level
Quarterturn 90°

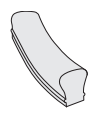

C7012
Up Easing



C7019
Opening Cap



C7021
Quarterturn
Cap 90°



C7020
Tandem Cap



C7022
Cap 45°

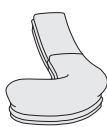

C7040
Left Hand
Turnout



C7045
Right Hand
Turnout

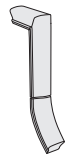

C7099
2 Riser
No Cap



CUSTOM MILLWORK, INC.

2298 North 2nd St. • North St. Paul, MN 55109 • 651-770-2356 • Fax 651-770-0439 • www.custommillworkinc.com

PROFILE	DESCRIPTION	OAK	MAPLE	POPLAR	CHERRY	K. ALDER
NEWELS						
C4002	3-1/2" Square × 56"	✓				
C4005	3-1/2" Square × 56"	✓				
C4015	3" Square × 60"	✓			✓	
C4040	3" Square × 47-1/2"	✓				
C4042	3" Square × 53-1/2"	✓	✓	✓	✓	
C4045	3" Square × 59-1/2"				✓	
S4SN	S4S Newel 3-1/2" × 56"	✓	✓	✓	✓	
C4075	3-1/2" Square × 58-1/4"	✓	✓	✓	✓	
C4077	3-1/2" Square × 57-1/2"	✓	✓	✓	✓	✓
C4090	5" Square × 55"	✓	✓	✓	✓	✓
C4091	6-1/4" Square × 55"	✓	✓	✓	✓	
C4092	6-1/4" Square × 55"	✓	✓	✓	✓	
C4890	7-1/2" Square × 54"	✓	✓	✓	✓	✓

✓ = STOCK ITEM



CUSTOM MILLWORK, INC.

2298 North 2nd St. • North St. Paul, MN 55109 • 651-770-2356 • Fax 651-770-0439 • www.custommillworkinc.com

NEWELS

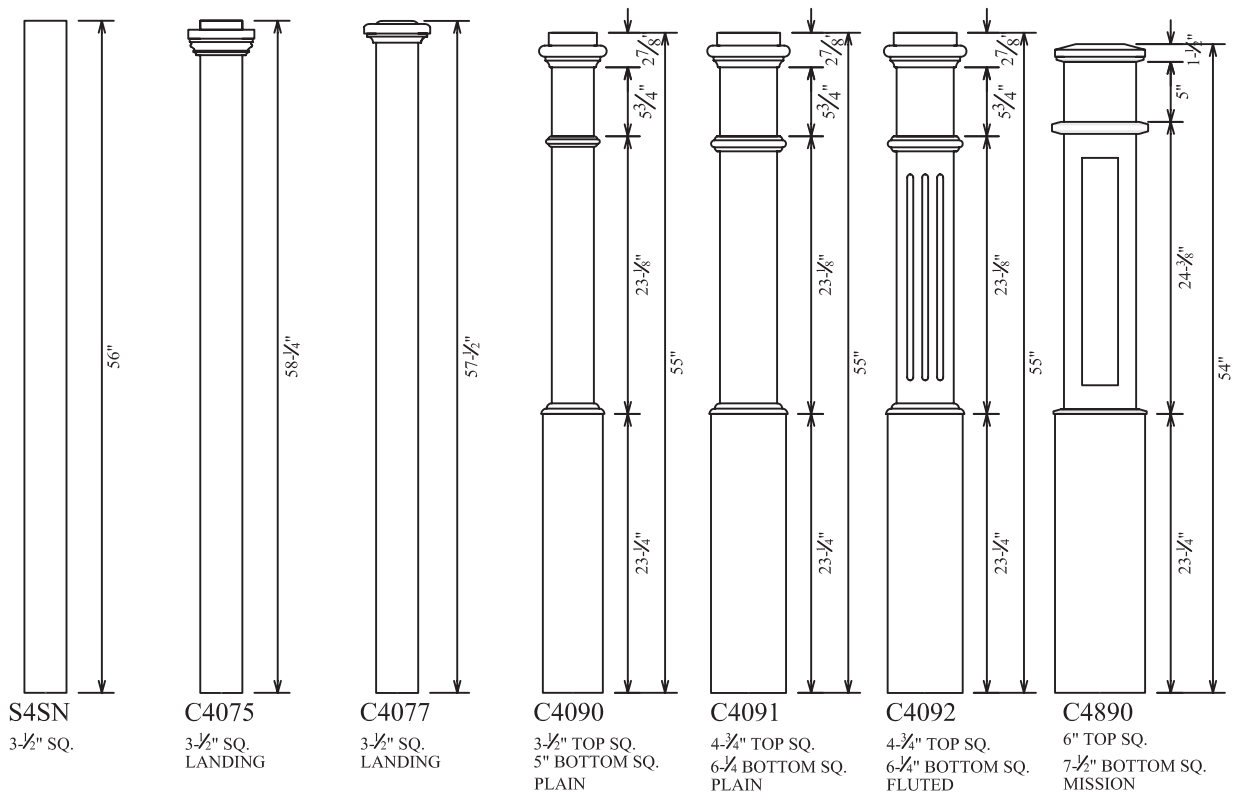
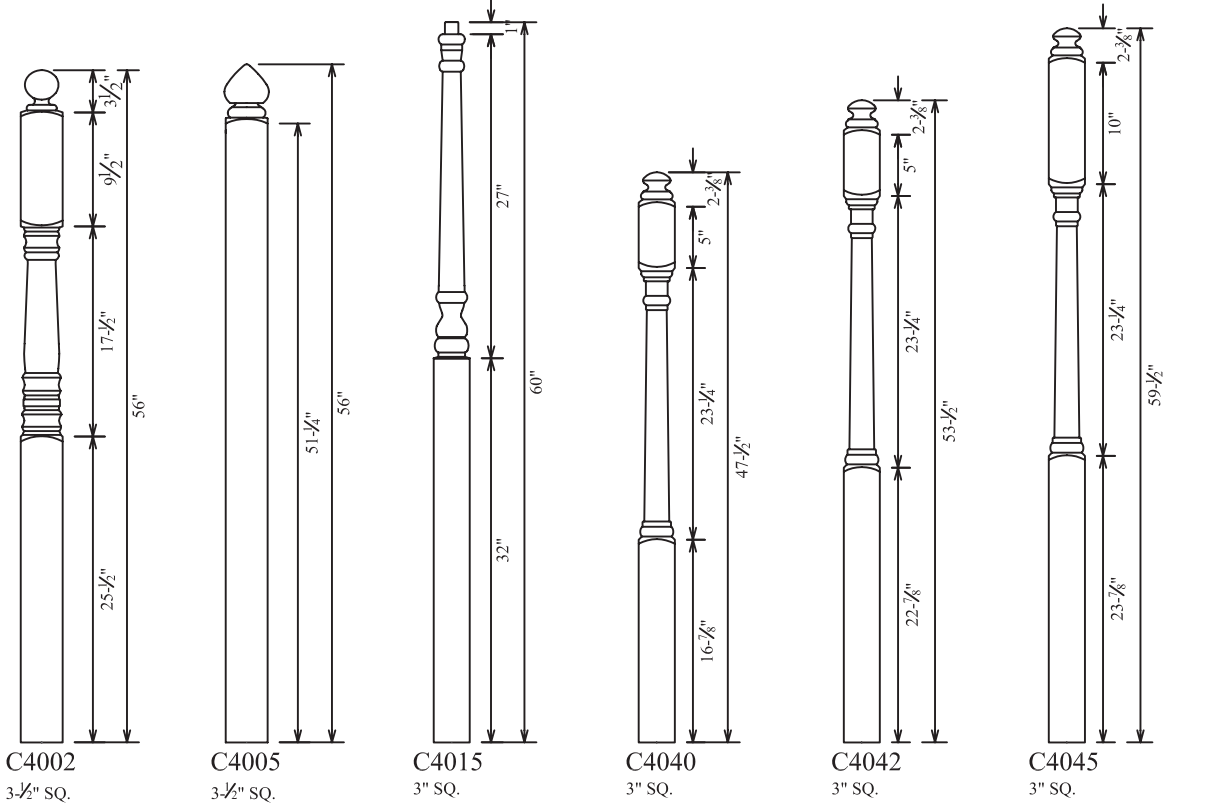

2298 North 2nd St. • North St. Paul, MN 55109 • 651-770-2356 • Fax 651-770-0439 • www.custommillworkinc.com

PROFILE	DESCRIPTION	OAK	MAPLE	PRIMED	CHERRY	POPLAR	K. ALDER
<i>CUSTOM WOOD BOX COLUMNS</i>							
	Fluted	✓	✓	✓	✓	✓	✓
	Smooth	✓	✓	✓	✓	✓	✓
<i>BUILD-UP CROWN</i>							
	C614/C280	✓	✓	✓	✓		
	C614/C610	✓	✓		✓		
<i>FIREPLACE MANTELS</i>							
	Style A	✓	✓	✓	✓		
	Style B	✓	✓	✓	✓		
	Style C	✓	✓	✓	✓		

✓ = STOCK ITEM



2298 North 2nd St. • North St. Paul, MN 55109 • 651-770-2356 • Fax 651-770-0439 • www.custommillworkinc.com

CUSTOM COLUMN IDEAS

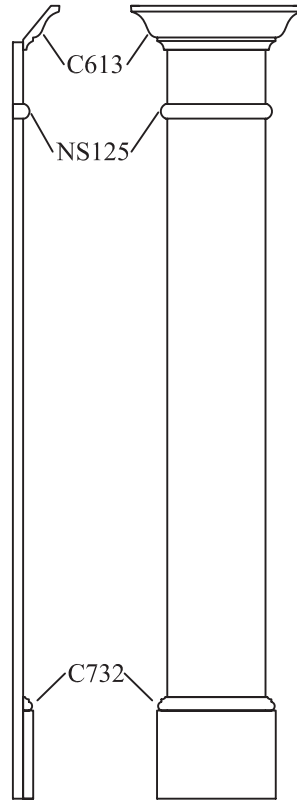
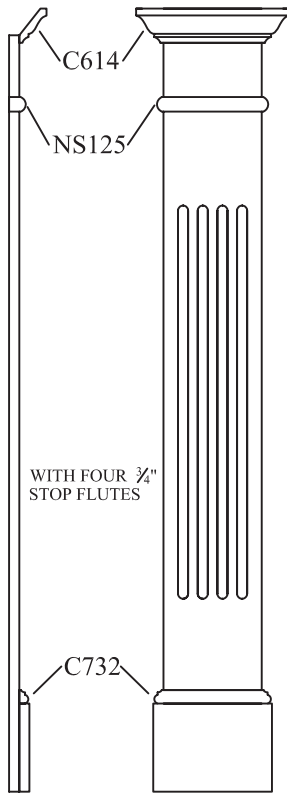

BUILD-UP CROWN IDEAS

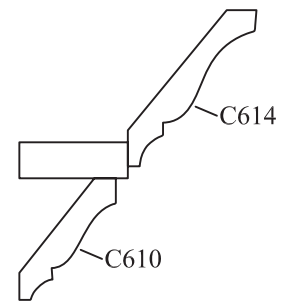
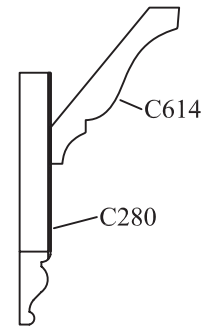

FIREPLACE MANTELS

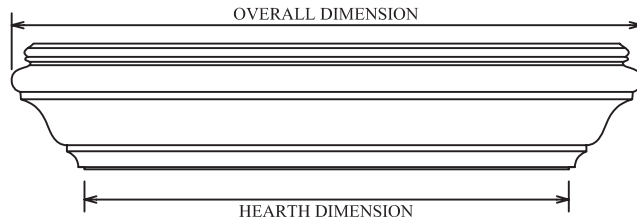
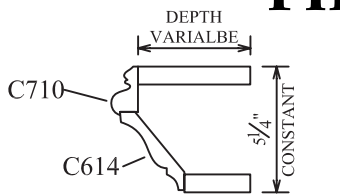

STYLE A

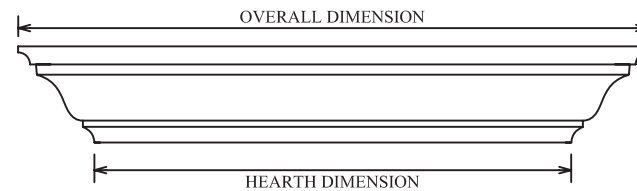
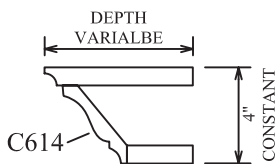

STYLE B

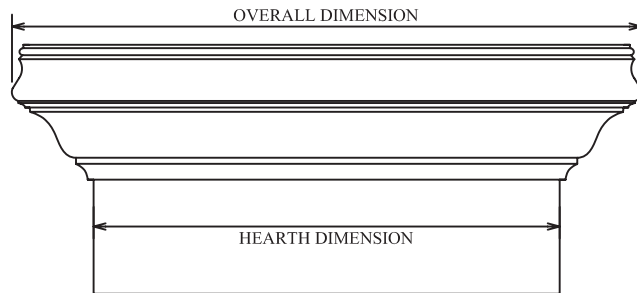
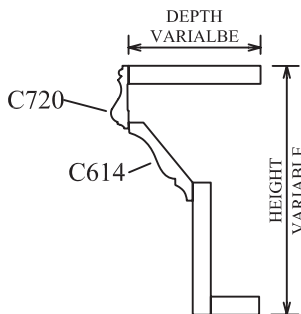

STYLE C



CUSTOM MILLWORK, INC.

2298 North 2nd St. • North St. Paul, MN 55109 • 651-770-2356 • Fax 651-770-0439 • www.custommillworkinc.com

